

We reserve all rights in this document and in the information contained therein. Reproduction, use or disclosure to third parties without express authority is strictly forbidden. INWIDO

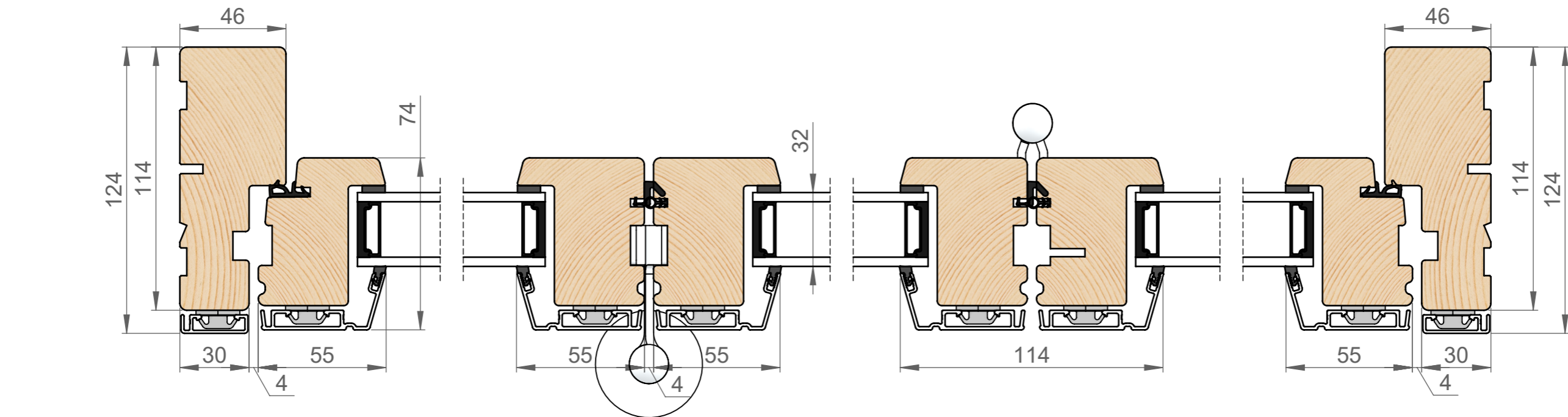

B-B  
1:2

A-A  
1:2

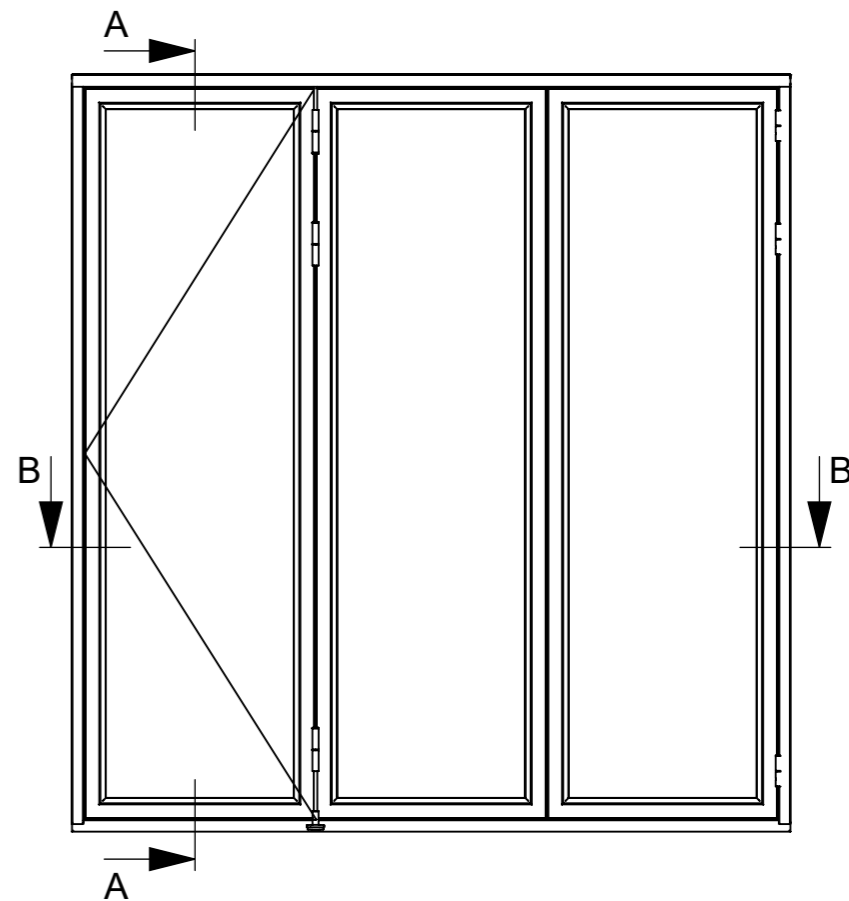

Ansvarlig afd.	Teknisk ref.	Godkendt af	Tegnet af	Dokument type	Dokument status	Revisions dato	Revision	Projektering	Målestok	Side
									1:20	6/6
Titel DK				* Samme tegning gælder for: 10 træ 2-lags, 30 træ 3-lags, 40 træ/alu 2-lags, 60 træ/alu 3-lags						
<b>frovin</b>				<b>Foldedøre, 2L TræAlu</b>						
DET OPRINDELIGE VINDUE				Title EN * Same drawing for: 10 wood 2-layer, 30 wood 3-layer, 40 wood/alu 2-layer, 60 wood/alu 3-layer						
Måleenhed				Papir størrelse		Tegnings dato		Tegnings nummer * 10/30/40/60		
mm				A3 stående						